

STANDARD PIT TYPES

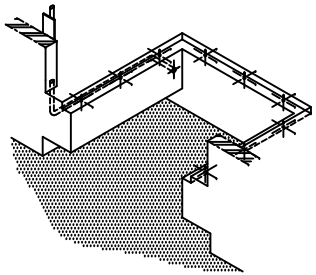

310.000

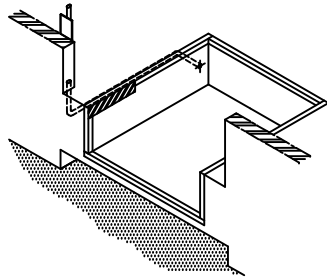

320.000

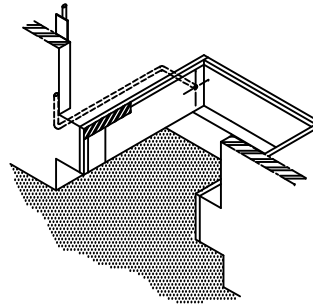

330.000

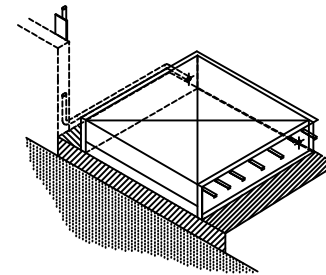

340.000

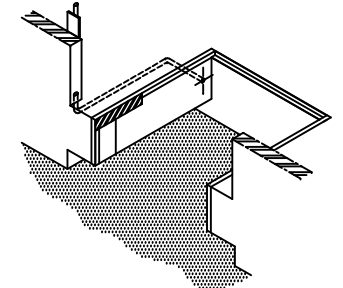

350.000

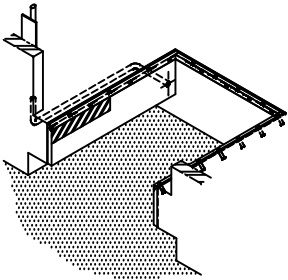

360.000

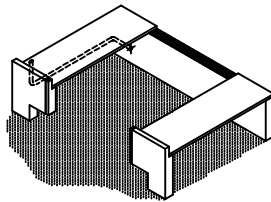

370.000

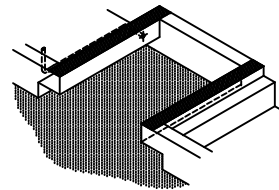

375.000

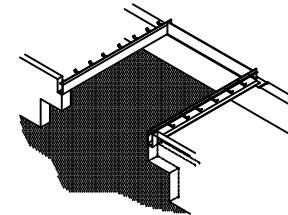

380.000

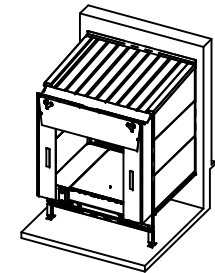

DOCK HOUSE

VARIATIONS TO THE STANDARD PIT TYPES

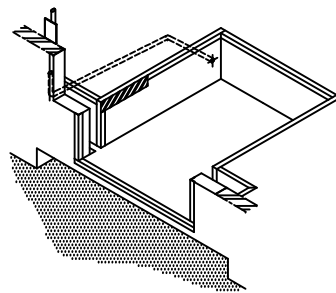
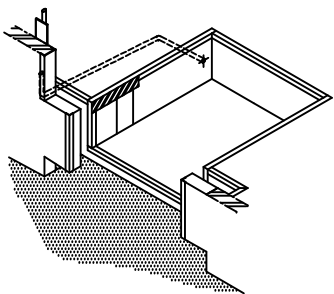

ISO-VERSION

- Please find enclosed some of the construction possibilities for LOADING SYSTEMS dock levellers, for more possibilities like industrial doors fill ground level or a pit box please contact us.
- Specified pit drawings are available on request.



Customer	:	Quotation No	:
Project	:	No	:
Architect	:	Date of issue	:
Your Ref. No	:		

SUMMARY OF
PIT TYPES

Scale: 1:50; 1:10 Tolerance: -0/+10

Doc. No: 04\E\0200\300000.DWG

Rev.: 09-06-2011

No: 300.000

